

WHITE FITTINGS

Outlet Fitting

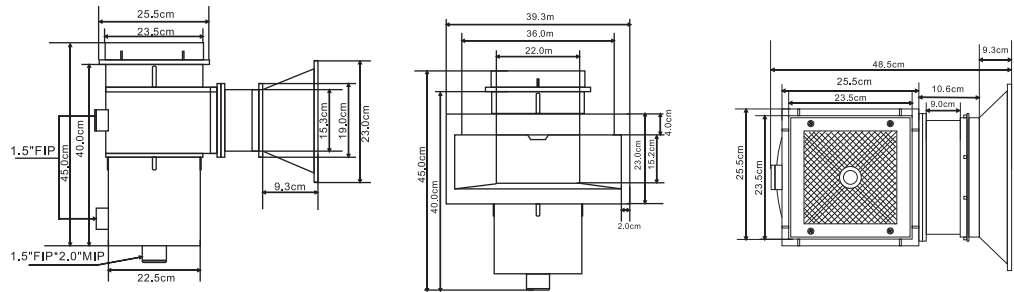

Model	Code	Material	Color	Threaded	Connection Size		Carton Qty
					Inner Dia	Outer Dia	
MD0030	90601	ABS	White	No	1.5"	2"	50

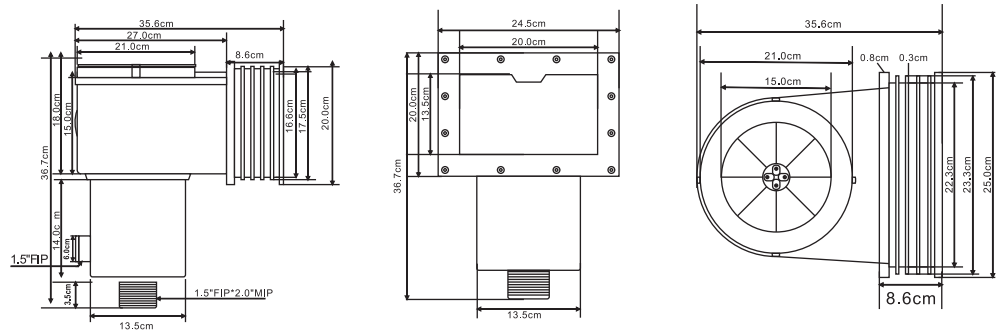

Model	Code	Material	Color	Threaded	Connection Size		Carton Qty
					Inner Ø	Outer Ø	
MD0040	90602	ABS	White	Yes	1.5"	2"	50

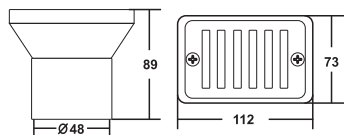

Model	Code	Material	Color	Threaded	Inner Ø	Height h	Carton Qty
HT-1019-48	81008	ABS	White	No	48mm	89mm	50
HT-1019-63	81005	ABS	White	No	63mm	99mm	50



Suction Fitting

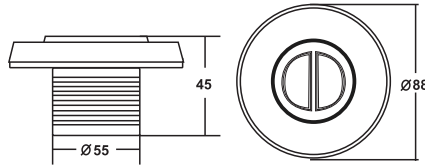

Model	Code	Material	Color	Threaded In & Out	Connection Size		Carton Qty
					Inner Ø	Outer Ø	
HT-1022 (Imperial)	81006	ABS	White	Yes	1.5"	2"	50
HT-1022 (Metric)	81006	ABS	White	Yes	50mm	60mm	50



Suction Fitting

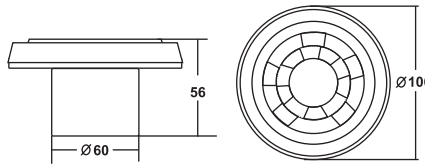

Model	Code	Material	Color	Threaded In & Out	Connection Size		Carton Qty
					Inner Ø	Outer Ø	
HT-1526 (Imperial)	81007	ABS	White	No	1.5"	2"	50
HT-1526 (Metric)	81007	ABS	White	No	50mm	60mm	50



Suction Fitting

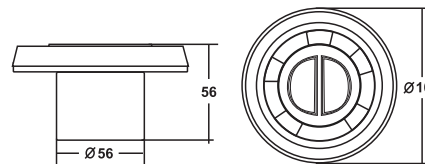

Model	Code	Material	Color	Threaded In & Out	Connection Size		Carton Qty
					Inner Ø	Outer Ø	
HT-1522 (Imperial)	81010	ABS	White	No	1.5"	2"	50
HT-1522 (Metric)	81010	ABS	White	No	50mm	60mm	50

WHITE FITTINGS



Main Drain

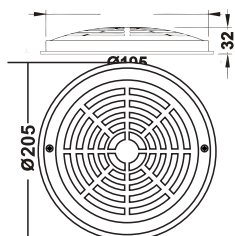

Model	Code	Material	Color	Carton Qty
HT-1030	81012	ABS	White	50



Square Main Drain(s)

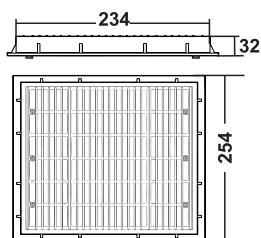

Model	Code	Material	Color	Carton Qty
HT-1031	81013	ABS	White	50

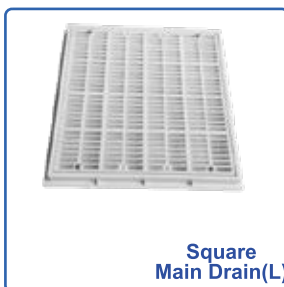

Square Main Drain(L)

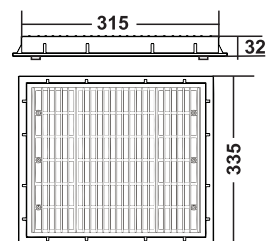

Model	Code	Material	Color	Carton Qty
HT-1032	81014	ABS	White	50



Anti-Vortex Square

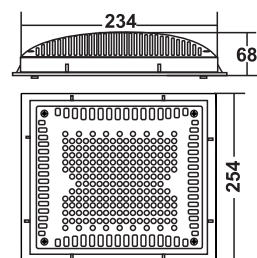

Model	Code	Material	Color	Carton Qty
HT-1031B	81015	ABS	White	50

Inlet Fitting

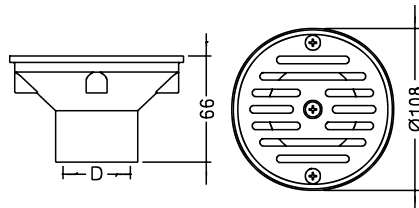

Model	Code	Material	Color	Threaded In & Out	Connection Size		Carton Qty
					Inner Ø	Outer Ø	
HT-1424N (Imperial)	81000	ABS	White	No	1.5"	2"	50
HT-1424N (Metric)	81000	ABS	White	No	50mm	60mm	50
HT-1424A (Imperial)	81001	ABS	White	Yes	1.5"	2"	50
HT-1424A (Metric)	81001	ABS	White	Yes	50mm	60mm	50

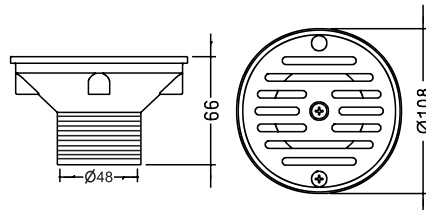

Model	Code	Material	Color	Threaded In & Out	Connection Size		Carton Qty
					Inner Ø	Outer Ø	
HT-1424SM (Imperial)	81002	ABS	White	Yes	1.5"	2"	50
HT-1424SM (Metric)	81002	ABS	White	Yes	50mm	60mm	50

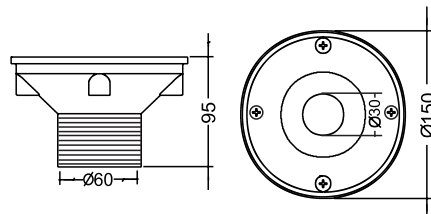

Model	Code	Material	Color	Threaded In & Out	Connection Size		Carton Qty
					Inner Ø	Outer Ø	
HT-1619 (Imperial)	81003	ABS	White	Yes	1.5"	2"	50
HT-1619 (Metric)	81003	ABS	White	Yes	50mm	60mm	50



Return Inlet

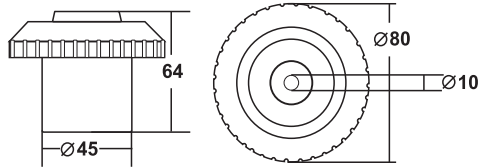

Model	Code	Material	Color	Threaded In & Out	Connection Size		Carton Qty
					Inner Ø	Outer Ø	
HT-1421B (Imperial)	81016	ABS	White	No	1.5"	2"	50
HT-1421B (Metric)	81016	ABS	White		50mm	60mm	50



Return Inlet

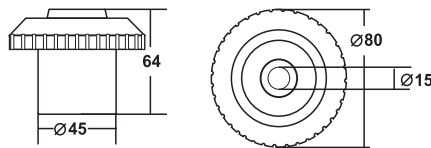

Model	Code	Material	Color	Threaded In & Out	Connection Size		Carton Qty
					Inner Ø	Outer Ø	
HT-1421C (Imperial)	81017	ABS	White	No	1.5"	2"	50
HT-1421C (Metric)	81017	ABS	White		50mm	60mm	50



Return Inlet

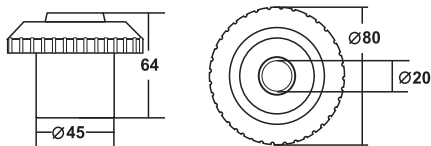

Model	Code	Material	Color	Threaded In & Out	Connection Size		Carton Qty
					Inner Ø	Outer Ø	
HT-1421D (Imperial)	81018	ABS	White	No	1.5"	2"	50
HT-1421D (Metric)	81018	ABS	White		50mm	60mm	50



Wall Return

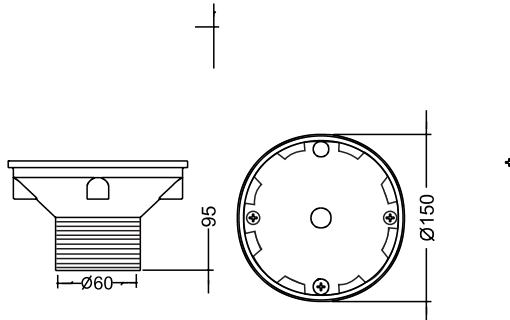

Model	Code	Material	Color	Threaded In & Out	Connection Size		Carton Qty
					Inner Ø	Outer Ø	
HT-1625 (Imperial)	81004	ABS	White	Yes	1.5"	2"	50
HT-1625 (Metric)	81004	ABS	White		50mm	60mm	50



Wall Return

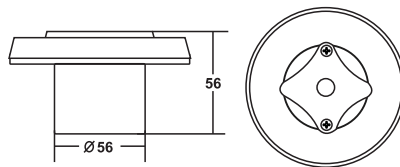

Model	Code	Material	Color	Threaded In & Out	Connection Size		Carton Qty
					Inner Ø	Outer Ø	
HT-1525 (Imperial)	81009	ABS	White	No	1.5"	2"	50
HT-1525 (Metric)	81009	ABS	White		50mm	60mm	50



Return Inlet

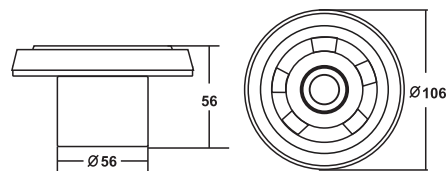

Model	Code	Material	Color	Threaded In & Out	Connection Size		Carton Qty
					Inner Ø	Outer Ø	
HT-1519 (Imperial)	81011	ABS	White	No	1.5"	2"	50
HT-1519 (Metric)	81011	ABS	White		50mm	60mm	50

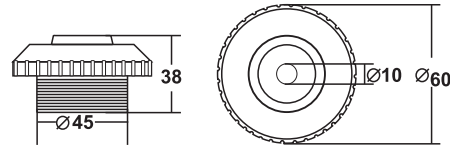

Model	Code	Material	Color	Threaded In & Out	Connection Size		Carton Qty
					Inner Ø	Outer Ø	
HT-1419B (Imperial)	81021	ABS	White	Yes	1.5"	2"	50
HT-1419B (Metric)	81021	ABS	White		50mm	60mm	50

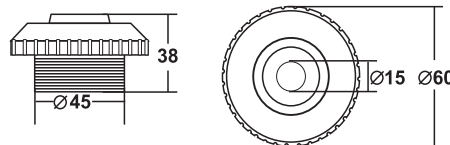

Model	Code	Material	Color	Threaded In & Out	Connection Size		Carton Qty
					Inner Ø	Outer Ø	
HT-1419C (Imperial)	81019	ABS	White	Yes	1.5"	2"	50
HT-1419C (Metric)	81019	ABS	White		50mm	60mm	50

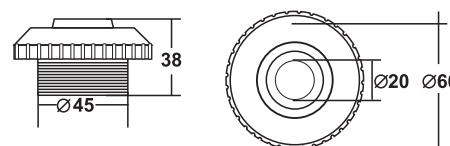

Model	Code	Material	Color	Threaded In & Out	Connection Size		Carton Qty
					Inner Ø	Outer Ø	
HT-1419D (Imperial)	81020	ABS	White	Yes	1.5"	2"	50
HT-1419D (Metric)	81020	ABS	White		50mm	60mm	50

Spa Jet

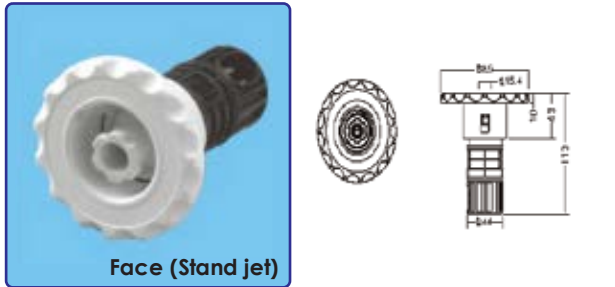

Model	Material	Color	Carton Qty
MD0034	ABS	White	50



Model	Material	Color	Carton Qty
MD0044	ABS	White	50



Model	Material	Color	Carton Qty
MD0028	ABS	White	50

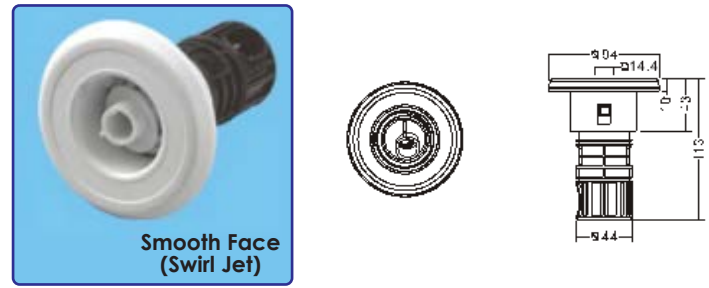

Model	Material	Color	Carton Qty
MD0048	ABS	White	50

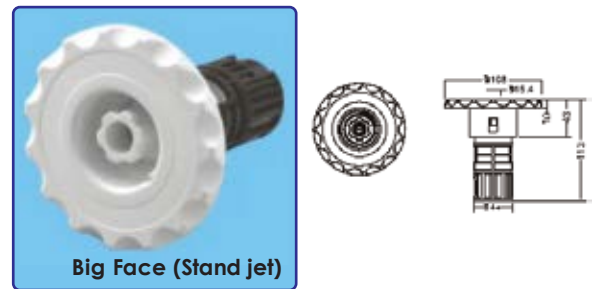

Model	Material	Color	Carton Qty
MD0064	ABS	White	50

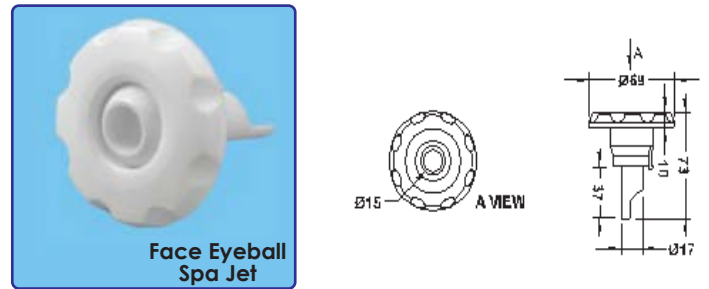

Model	Material	Color	Carton Qty
MD1113	ABS	White	50

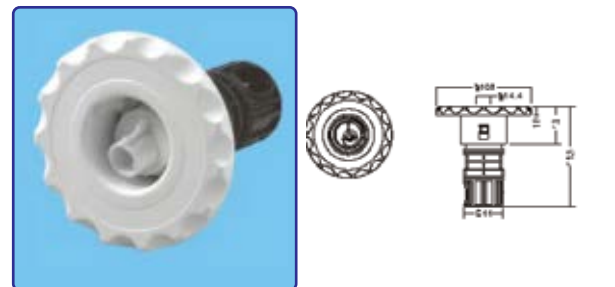

Model	Material	Color	Carton Qty
MD0018	ABS	White	50



Model	Material	Color	Carton Qty
MD1123	ABS	White	50

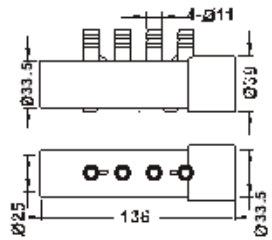

4 Port Air Barb Manifold

Model	Material	Color	Carton Qty
MD1825	ABS	White	50

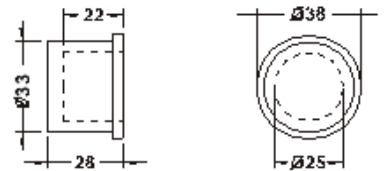

Pipe Plug

Model	Material	Color	Carton Qty
MD1818	ABS	White	50

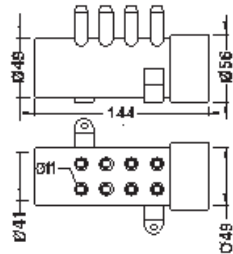

8 Port Air Manifold

Model	Material	Color	Carton Qty
MD1865	ABS	White	50

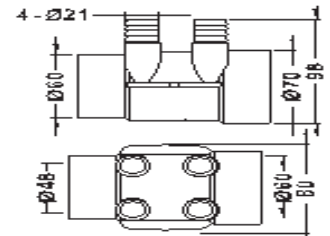

4 Port Water Barb Manifold

Model	Material	Color	Carton Qty
MD1824	ABS	White	50

Jointer Water Manifold

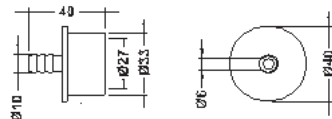

Barb Plug

Model	Material	Color	Carton Qty
MD1815	ABS	White	50

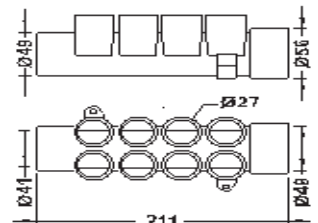

8 Port Water Manifold

Model	Material	Color	Carton Qty
MD1864	ABS	White	50

Bath Jet & Drain Assembly

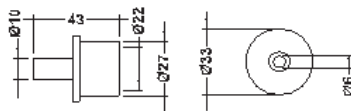

Barb Plug

Model	Material	Color	Carton Qty
MD1816	ABS	White	50

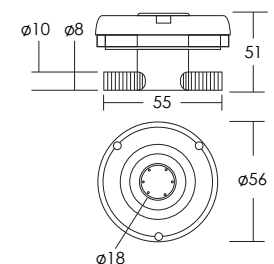

Face & Barb Jet

Model	Material	Color	Carton Qty
MD0054	ABS	White	50

EII Body Assembly

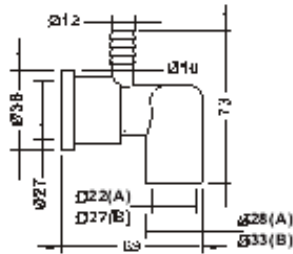

Model	Material	Color	Carton Qty
MD2201(A)	ABS	White	50

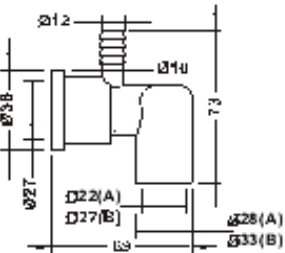
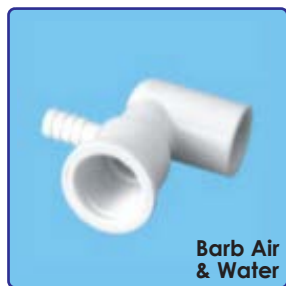

Model	Material	Color	Carton Qty
MD2201(B)	ABS	White	50

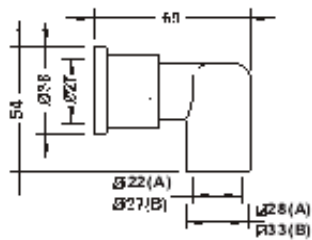

Model	Material	Color	Carton Qty
MD2202(A)	ABS	White	50

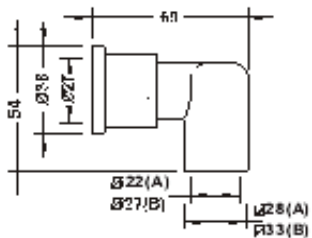

Model	Material	Color	Carton Qty
MD2202(A)	ABS	White	50

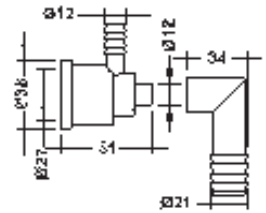

Model	Material	Color	Carton Qty
MD2203(A)	ABS	White	50

Air System

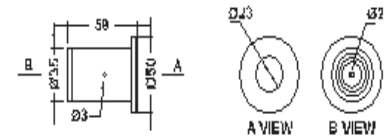

Model	Material	Color	Carton Qty
MD1844	ABS	White	50

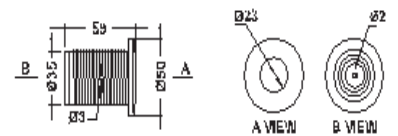

Model	Material	Color	Carton Qty
MD1845	ABS	White	50

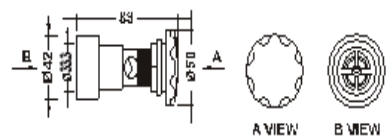

Model	Material	Color	Carton Qty
MD1834	ABS	White	50

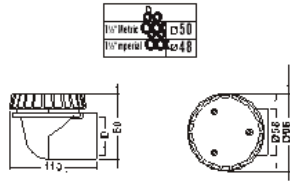

Model	Material	Color	Carton Qty
MD3822(A)	ABS	White	50

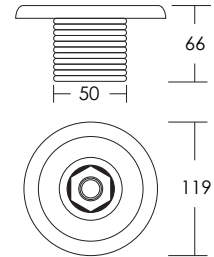

with ext. 2" and int. Diameter of 50mm

Model	Material	Color	Carton Qty
MD0295V	ABS	White	50

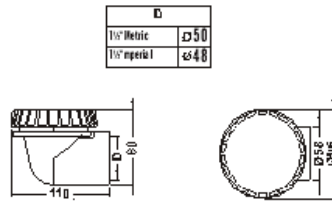

Model	Material	Color	Carton Qty
MD3822(B)	ABS	White	50

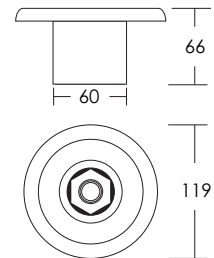

with ext. 60mm and int. Diameter of 50mm

Model	Material	Color	Carton Qty
MD0298	ABS	White	50

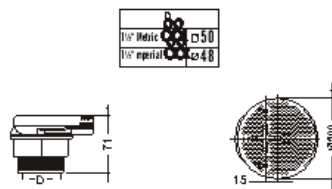

Model	Material	Color	Carton Qty
MD3811	ABS	White	50

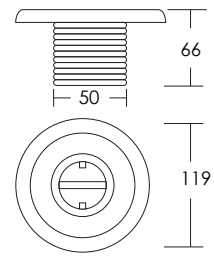

with ext. 60mm and int. Diameter of 50mm

Model	Material	Color	Carton Qty
MD0330	ABS	White	50

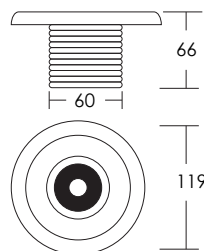

with ext. 2" and int. Diameter of 50mm

Model	Material	Color	Carton Qty
MD0295C	ABS	White	50

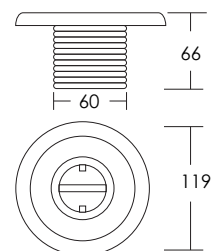

with 50mm int. & 2" ext. Joint

Model	Material	Color	Carton Qty
MD00301C	ABS	White	50



Suction Inlet for Vinyl Pool, Threaded

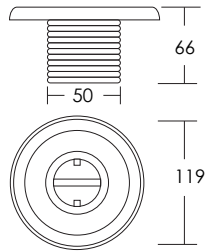

with 50mm int. & 2" ext. Joint

Model	Material	Color	Carton Qty
MD2831V	ABS	White	50



Junction Box

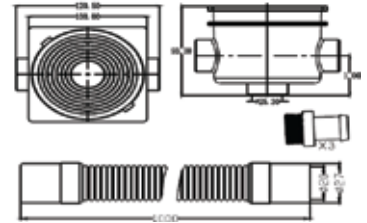

Model	Material	Color	Carton Qty
MD2823	ABS	White	50



Bottom Inlet for Concrete Pool

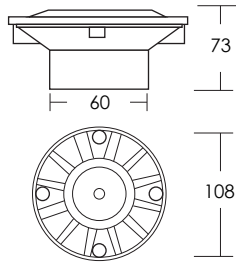

with 50mm int. & 2" ext. fitting

Model	Material	Color	Carton Qty
MD2825C	ABS	White	50

MD00324E: Wall Conduit Non-Threaded Fitting (Slip Fit)

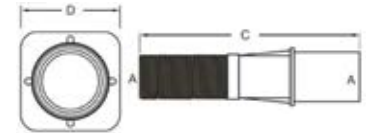

Made of grey ABS, length 300 mm, 50mm rear male thread and Ø2" smooth inner wall for gluing slip fit inlets or mini dichromatic lights.

Model	Material	Color	A(mm)	B(in)	C(mm)	D(mm)
MD00324E	ABS	Grey	50	2	300	80



Bottom Inlet for Vinyl Pool

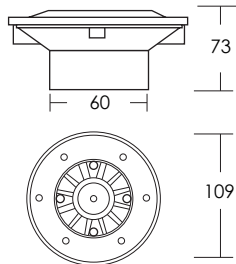

with 50mm int. & 2" ext. fitting

Model	Material	Color	Carton Qty
MD2825V	ABS	White	50

MD00324H: Wall Conduit Threaded Fitting

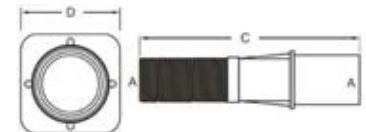

Made of grey ABS, length 300mm, 50mm rear male thread and Ø2" female threaded connection for threaded inlets or mini dichromatic lights.

Model	Material	Color	A(mm)	B(in)	C(mm)	D(mm)
MD00324H	ABS	Grey	50	2	300	80



Circular ABS Main Drain for Concrete Pool

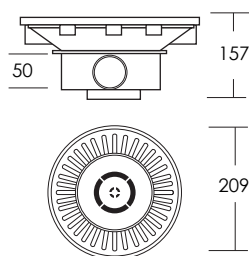

with 170mm in Diameter & 2" int. tr

Model	Material	Color	Carton Qty
MD146C	ABS	White	50



Printed in Australia
By BPA

Distributed internationally by Minder Water Industries Sdn. Bhd. All rights reserved 2018.
Distributed in Australia by Minder Water Industries Pty. Ltd.
Distributed in China by Minder Water Industries (Canton) Co. Ltd.
Distributed in South-East Asia by Minder Water Industries Sdn. Bhd.